



Project Name _____

Date _____ Type _____

Notes _____

APPLICATIONS

Lighting installations for side and top mounting of luminaires with effective projected area (EPA) not exceeding maximum allowable loading of the specified pole in its installed geographic location.

CONSTRUCTION

Shaft:	One-piece straight steel with square cross section, flat sides and minimum 0.23" radius on all corners; Minimum yield of 46,000 psi (ASTM-A500, Grade B); Longitudinal weld seam to appear flush with shaft side wall; Steel base plate with axial bolt circle slots welded to pole shaft having minimum yield of 36,000 psi (ASTM A36)
Base Cover:	Two-piece square aluminum base cover included standard
Pole Cap:	Pole shaft supplied with removable cover when applicable; Tenon and post-top configurations also available
Hand Hole:	Rectangular 3x5 steel hand hole frame (2.38" x 4.38" opening); Mounting provisions for grounding lug located behind gasketed cover
Anchor Bolts:	Four galvanized anchor bolts provided per pole with minimum yield of 55,000 psi (ASTM F1554). Galvanized hardware with two washers and two nuts per bolt for leveling
Anchor Bolt Part Numbers:	<ul style="list-style-type: none"> • 3/4 x 30 x 3 — TAB-30-M38 • 1 x 36 x 4 — TAB-36-M38

FINISH

- Durable thermoset polyester powder coat paint finish with nominal 3.0 mil thickness
- Powder paint prime applied over "white metal" steel substrate cleaned via mechanical shot blast method
- Decorative finish coat available in multiple standard colors; Custom colors available; RAL number preferable



10 DAY - EVOLVE EXPRESS SHIP PROGRAM

- Ships in 10 days
- Limit of 15 poles

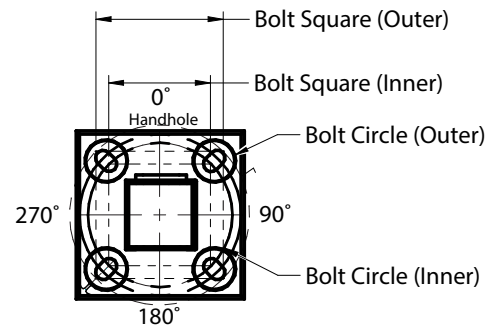
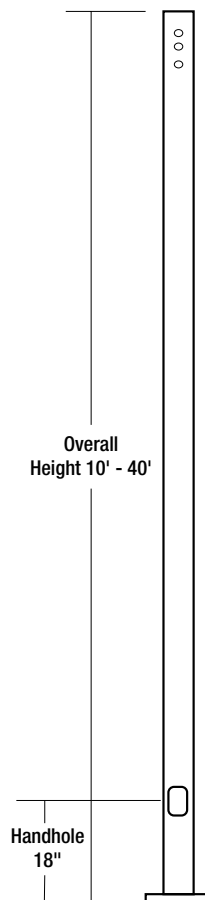

BASE DETAIL

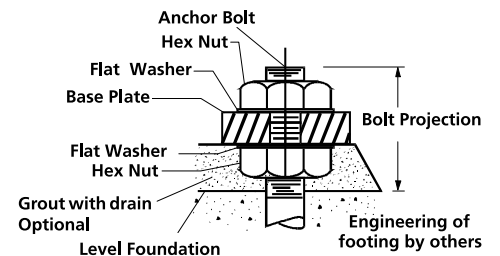

POLE CAP

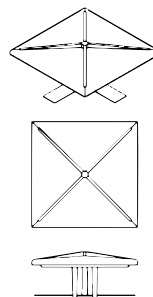

TENON

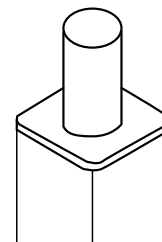

BASE COVER

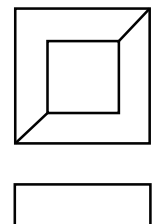

Example: SSSE25-40A-2-E2-DKBZ-UL

SSSE

E2

SERIES	HEIGHT	SHAFT	THICKNESS	MOUNTING	POLE DRILLING	FINISH	OPTIONS
SSSE = Evolve Square Straight Steel Pole EXS	10=10 ft.	40=4" Square	A=0.125"	1 = Single arm mount EXS	E2 = Evolve Square Pole EXS UDP01⁵ = 3/8in HDW range 1.69 - 2.24 UDP02⁵ = 1/2in HDW range 1.69 - 2.24 UDP03⁵ = 3/8in HDW range 2.25 - 2.99 UDP04⁵ = 1/2in HDW range 2.25 - 2.99 UDP05⁵ = 3/8in HDW range 3.00 - 3.75 UDP06⁵ = 9/16in HDW range 3.00 - 3.75 UDP07⁵ = 3/8in HDW range 3.76 - 4.49 UDP08⁵ = 9/16in HDW range 3.76 - 4.49 UDP09⁵ = 3/8in HDW range 4.50 - 5.49 UDP10⁵ = 9/16in HDW range 4.50 - 5.49 UDP11⁵ = 3/8in HDW range 5.50 - 6.00 UDP12⁵ = 9/16in HDW range 5.50 - 6.00	DKBZ = Dark Bronze EXS BLCK = Black GRAY = Gray <i>* Contact factory for custom color options</i>	GFI² = 20 Amp GFCI Receptacle and Cover EHH² = Extra Handhole C05² = 0.5" Coupling C07² = 0.75" Coupling C20² = 2" Coupling MPB² = Mid-pole Luminaire Bracket VM1 = 1st mode vibration damper VM2⁶ = 2nd mode vibration damper LAB = Less Anchor EXS Bolts UL = UL Certified
	12=12 ft.	40=4" Square	A=0.125"	2 = Two fixtures at 180° EXS			
	14=14 ft.	40=4" Square	A=0.125"	2L = Two fixtures at 90° EXS			
	16=16 ft.	40=4" Square	A=0.125" EXS	3T = Three fixtures at 90° EXS			
		50=5" Square	B=.188"	3Y = Three fixtures at 120° EXS			
	18=18 ft.	40=4" Square	B=.188"	4 = Four fixtures at 90° EXS			
		50=5" Square	B=.188"	TA ³ = Tenon (2.38" OD x 4" Tall) EXS			
		60=6" Square	B=.188"	TB ³ = Tenon (2.88" OD x 4" Tall) EXS			
	20=20 ft.	40=4" Square	B=.188"	TC ³ = Tenon (3.5" OD x 6" Tall)			
		50=5" Square	B=.188"	TR ¹ = Removable Tenon (2.38" x 4")			
		60=6" Square	B=.188"	OT = Open Top (includes pole cap) EXS			
	25=25 ft.	40=4" Square	A=0.125" EXS				
		50=5" Square	B=.188"				
		60=6" Square	B=.188"				
	30=30 ft.	40=4" Square	B=.188" EXS				
		50=5" Square	B=.188" EXS				
60=6" Square		B=.188"					
35=35 ft.	60=6" Square	B=.188"					
40=40 ft.	60=6" Square	B=.188"					

NOTES:

- Removable tenon used in conjunction with side arm mounting. First specify desired arm.
- Specify option location using MOUNTING ORIENTATION logic shown on this page.
- Not available with VM1 - Mode Vibration Damper.
- VM1 recommended on poles 20' and taller with EPA of less than 1. Field installed.
- UDP allow mounting of most popular fixtures on the market
- Factory Installed.

EXS Indicates availability in the **EXS 10 Day Evolve Express Ship Program**

MOUNTING ORIENTATION

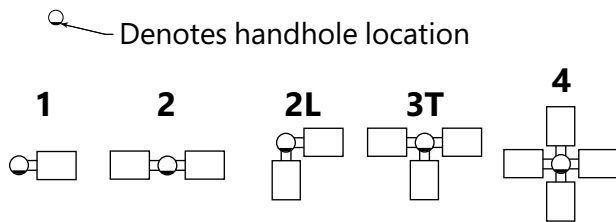

ACCESSORIES- ORDER SEPARATELY

CATALOG NUMBER	DESCRIPTION
VM1 ³	1st mode vibration damper
VM2SXX*	2nd mode vibration damper

* XX = 08 for 8', 12 for 12', 15 for 16', 20 for 20', and 24' for 24'.

Note: Field Installed through handhole

DRILL PATTERNS

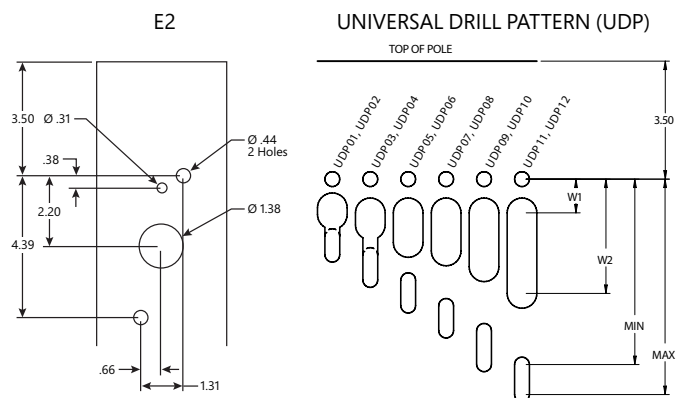

MOUNTING HARDWARE		Universal Mounting Patterns					
3/8" OR LESS	7/16" TO 1/2"	UDP01	UDP03	UDP05	UDP07	UDP09	UDP11
1.69	2.25	3.00	3.76	4.50	5.50		
2.24	2.99	3.75	4.49	5.49	6.00		
0.85	1.00	1.00	1.00	1.00	1.00		
1.05	1.36	1.88	2.13	2.60	3.00		

CATALOG NUMBER	HEIGHT		NOMINAL SHAFT DIMENSIONS	WALL THICKNESS	BOLT CIRCLE (SUGGESTED)	BOLT CIRCLE (RANGE)	BOLT SQUARE (RANGE)	BASE PLATE SQUARE	ANCHOR BOLT SIZE	BOLT PROJECTION	POLE WEIGHT
	FEET	METERS									
SSSE10-40A	10	3.0	4" square	0.125"	9"	8"-10"	5.66"-7.07"	9"	3/4"x30"x3"	3.5	77
SSSE12-40A	12	3.7	4" square	0.125"	9"	8"-10"	5.66"-7.07"	9"	3/4"x30"x3"	3.5	90
SSSE14-40A	14	4.3	4" square	0.125"	9"	8"-10"	5.66"-7.07"	9"	3/4"x30"x3"	3.5	103
SSSE16-40A EXS	16	4.9	4" square	0.125"	9"	8"-10"	5.66"-7.07"	9"	3/4"x30"x3"	3.5	116
SSSE18-40A EXS	18	5.5	4" square	0.125"	9"	8"-10"	5.66"-7.07"	9"	3/4"x30"x3"	3.5	129
SSSE20-40A EXS	20	6.1	4" square	0.125"	9"	8"-10"	5.66"-7.07"	9"	3/4"x30"x3"	3.5	142
SSSE25-40A EXS	25	7.6	4" square	0.125"	9"	8"-10"	5.66"-7.07"	9"	3/4"x30"x3"	3.5	175

SSSE14-40B	14	4.3	4" square	.188"	11"	10"-12"	7.07"-8.48"	10.50"	3/4"x30"x3"	3.5	152
SSSE16-40B	16	4.9	4" square	.188"	11"	10"-12"	7.07"-8.48"	10.50"	3/4"x30"x3"	3.5	171
SSSE18-40B	18	5.5	4" square	.188"	11"	10"-12"	7.07"-8.48"	10.50"	3/4"x30"x3"	3.5	190
SSSE20-40B	20	6.1	4" square	.188"	11"	10"-12"	7.07"-8.48"	10.50"	3/4"x30"x3"	3.5	209
SSSE25-40B	25	7.6	4" square	.188"	11"	10"-12"	7.07"-8.48"	10.50"	3/4"x30"x3"	3.5	257
SSSE30-40B EXS	30	9.1	4" square	.188"	11"	10"-12"	7.07"-8.48"	10.50"	3/4"x30"x3"	3.5	304

SSSE16-50B	16	4.9	5" square	.188"	11"	10.25"-13.25"	7.25"-9.37"	11.50"	1"x36"x4"	4.5	219
SSSE18-50B	18	5.5	5" square	.188"	11"	10.25"-13.25"	7.25"-9.37"	11.50"	1"x36"x4"	4.5	243
SSSE20-50B	20	6.1	5" square	.188"	11"	10.25"-13.25"	7.25"-9.37"	11.50"	1"x36"x4"	4.5	267
SSSE25-50B	25	7.6	5" square	.188"	11"	10.25"-13.25"	7.25"-9.37"	11.50"	1"x36"x4"	4.5	327
SSSE30-50B EXS	30	9.1	5" square	.188"	11"	10.25"-13.25"	7.25"-9.37"	11.50"	1"x36"x4"	4.5	387

SSSE25-50C	25	7.6	5" square	.25"	11"	10.25"-13.25"	7.25"-9.37"	11.50"	1"x36"x4"	4.5	427
SSSE30-50C	30	9.1	5" square	.25"	11"	10.25"-13.25"	7.25"-9.37"	11.50"	1"x36"x4"	4.5	507

SSSE20-60B	20	6.1	6" square	.188"	12"	11.00"-13.25"	7.81"-9.37"	12.25"	1"x36"x4"	5.0	329
SSSE25-60B	25	7.6	6" square	.188"	12"	11.00"-13.25"	7.81"-9.37"	12.25"	1"x36"x4"	5.0	404
SSSE30-60B	30	9.1	6" square	.188"	12"	11.00"-13.25"	7.81"-9.37"	12.25"	1"x36"x4"	5.0	479
SSSE35-60B	35	10.7	6" square	.188"	12"	11.00"-13.25"	7.81"-9.37"	12.25"	1"x36"x4"	5.0	554
SSSE40-60B	40	12.2	6" square	.188"	12"	11.00"-13.25"	7.81"-9.37"	12.25"	1"x36"x4"	5.0	629

NOTES:

1. Factory supplied template must be used when setting anchor bolts. Current will deny any claim for incorrect anchorage placement resulting from failure to use factory supplied template and anchor bolts.

EHH EXTRA HANDHOLE

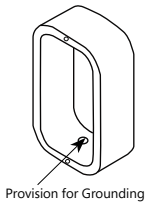

C05 - C07 - C20 - COUPLING

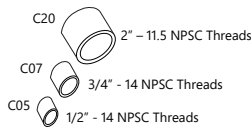

VM1 - VIBRATION DAMPER 1ST MODE

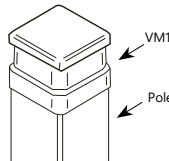

Field Installed Pole Top damper designed to reduce pole top deflection or sway. VM1 is recommended for pole systems 20' and taller with a total EPA of 1.0 or less.

VM2 - VIBRATION DAMPER 2ND MODE



Factory installed, internal damper designed to alter pole resonance to reduce movement and material fatigue caused by 2nd mode vibration.

VM2SXX - VIBRATION DAMPER 2ND MODE



VM2S08 - 8'
VM2S12 - 12'
VM2S16 - 16'
VM2S20 - 20'
VM2S24 - 24'

Field installed, internal damper designed to alter pole resonance to reduce movement and material fatigue caused by 2nd mode vibration.

GFI - 20 AMP GFCI RECEPTACLE & COVER

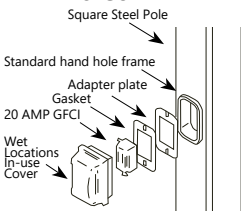

MPB - MID POLE BRACKET

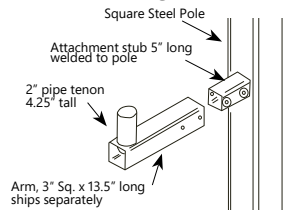

OPTION ORIENTATION

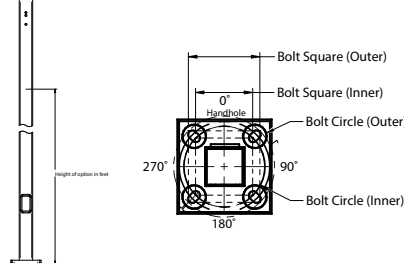

Follow the logic below when ordering location specific options. For each option, include its orientation (in degrees) and its height (in feet).

Example:
Option C07 should be ordered as: SSSE20-40A-TA-E2-DBT-C07-0-15 (.5" coupling on the handhole/arm side of pole, 15 feet up from the pole base) 1" spacing required between option. Consult factory for other configurations.

SSSE Series Poles

Square | Straight | Steel

EPA Load Rating - Wind Maps

Project Name _____

Date _____ Type _____

Notes _____

ASCE7-05 WIND MAP

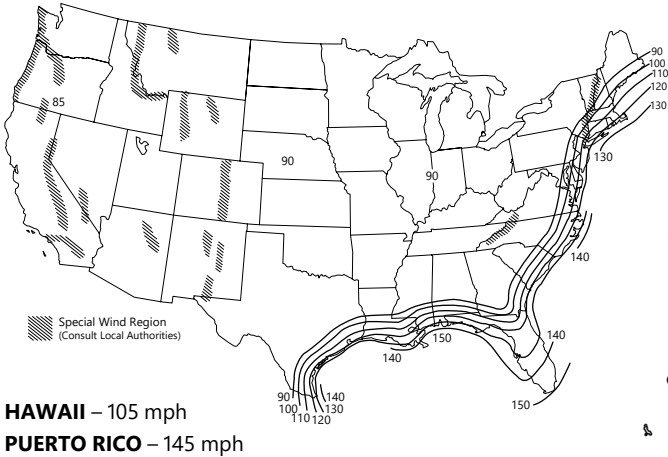

HAWAII – 105 mph
PUERTO RICO – 145 mph

*Printed with permission from ASCE

FLORIDA REGION WIND MAP

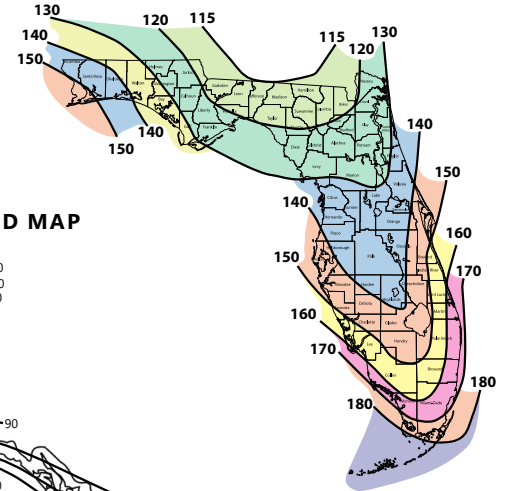

Florida region wind map above is based upon 3-second gust winds and the 2017 Florida Building Code

ALASKA REGION WIND MAP

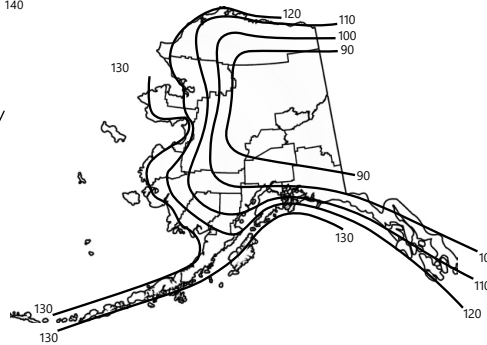

ASCE 7-05 wind map EPA Load Rating - 3 second gust wind speeds (Use for all locations except Florida)										
Catalog Number	85	90	100	105	110	120	130	140	145	150
SSSE10-40A	25.0	25.0	25.0	22.8	20.6	17.0	14.2	11.9	11.0	10.1
SSSE12-40A	25.0	25.0	20.0	18.0	16.1	13.2	10.8	8.9	8.1	7.4
SSSE14-40A	23.1	20.4	16.1	14.3	12.8	10.2	8.2	6.6	5.9	5.3
SSSE16-40A	19.0	16.7	13.0	11.5	10.1	7.9	6.2	4.7	4.1	3.6
SSSE18-40A	15.6	13.6	10.0	9.0	7.8	5.9	4.4	3.1	2.6	2.1
SSSE20-40A	12.7	10.9	7.9	6.9	5.9	4.2	2.8	1.7	1.3	0.9
SSSE25-40A	7.3	5.9	3.8	2.9	2.1	0.8	NR	NR	NR	NR
SSSE14-40B	25.0	25.0	23.3	20.8	18.6	15.1	12.3	10.2	9.2	8.4
SSSE16-40B	25.0	24.9	19.4	17.3	15.4	12.3	9.9	8.0	7.2	6.4
SSSE18-40B	24.0	20.8	16.1	14.2	12.5	9.8	7.7	6.1	5.3	4.7
SSSE20-40B	20.2	17.5	13.2	11.6	10.1	7.7	5.9	4.4	3.8	3.2
SSSE25-40B	12.8	11.0	7.9	6.7	5.5	3.7	2.3	1.2	0.7	NR
SSSE30-40B	8.0	6.6	4.1	3.1	2.2	0.8	NR	NR	NR	NR
SSSE16-50B	25.0	25.0	25.0	25.0	24.8	20.1	16.5	13.6	12.3	11.2
SSSE18-50B	25.0	25.0	25.0	22.9	20.4	16.4	13.2	10.7	9.6	8.6
SSSE20-50B	25.0	25.0	21.3	18.9	16.7	13.2	10.4	8.1	7.2	6.3
SSSE25-50B	20.7	17.8	13.3	11.5	9.8	7.2	5.0	3.3	2.6	1.9
SSSE30-50B	13.5	11.3	7.7	6.2	4.9	2.8	1.1	NR	NR	NR
SSSE25-50C	25.0	25.0	19.4	17.1	15.1	11.7	9.0	6.9	6.0	5.1
SSSE30-50C	20.1	17.3	12.7	10.9	9.3	6.6	4.5	2.8	2.1	1.4
SSSE20-60B	25.0	25.0	25.0	25.0	25.0	20.2	16.1	12.9	11.5	10.3
SSSE25-60B	25.0	25.0	20.6	18.0	15.6	11.8	8.7	6.2	5.2	4.2
SSSE30-60B	21.4	18.1	12.9	10.7	8.8	5.7	3.3	1.3	NR	NR
SSSE35-60B	14.0	11.3	6.9	5.2	3.6	1.0	NR	NR	NR	NR
SSSE40-60B	8.1	5.8	2.2	NR	NR	NR	NR	NR	NR	NR

Florida Building Code 2017 EPA Load Rating - 3 second gust wind speeds (Use for Florida only)								
Catalog Number	115	120	130	140	150	160	170	180
SSSE10-40A	25.0	25.0	25.0	25.0	21.4	18.4	15.9	13.9
SSSE12-40A	25.0	25.0	23.6	19.8	16.7	14.2	12.1	10.4
SSSE14-40A	25.0	23.1	19.0	15.7	13.1	10.9	9.1	7.6
SSSE16-40A	20.8	18.7	15.2	12.3	10.1	8.2	6.7	5.4
SSSE18-40A	16.8	15.0	11.9	9.4	7.5	5.9	4.5	3.4
SSSE20-40A	13.6	11.9	9.2	7.1	5.3	3.9	2.7	1.7
SSSE25-40A	7.4	6.2	4.1	2.5	1.1	NR	NR	NR
SSSE14-40B	25.0	23.6	19.4	16.1	13.4	11.2	9.4	7.8
SSSE16-40B	21.4	19.2	15.6	12.7	10.4	8.5	6.9	5.6
SSSE18-40B	17.2	15.4	12.2	9.7	7.7	6.1	4.7	3.6
SSSE20-40B	13.9	12.3	9.5	7.3	5.5	4.1	2.9	1.9
SSSE25-40B	7.7	6.4	4.3	2.6	1.3	NR	NR	NR
SSSE30-40B	3.2	2.1	NR	NR	NR	NR	NR	NR
SSSE16-50B	25.0	25.0	25.0	25.0	25.0	21.4	18.2	15.5
SSSE18-50B	25.0	25.0	25.0	24.4	20.4	17.0	14.2	11.9
SSSE20-50B	25.0	25.0	24.4	19.9	16.3	13.4	11.0	8.9
SSSE25-50B	21.8	19.3	15.0	11.5	8.8	6.5	4.7	3.1
SSSE30-50B	13.7	11.7	8.2	5.5	3.3	1.5	NR	NR
SSSE25-50C	21.8	19.3	15.0	11.5	8.8	6.5	4.7	3.1
SSSE30-50C	13.7	11.7	8.2	5.5	3.3	1.5	NR	NR
SSSE20-60B	25.0	25.0	25.0	21.9	17.8	14.5	11.7	9.4
SSSE25-60B	23.8	20.9	16.1	12.3	9.2	6.6	4.5	2.8
SS-E30-60B	14.6	12.3	8.4	5.3	2.8	0.8	NR	NR
SSSE35-60B	7.5	5.6	2.4	NR	NR	NR	NR	NR
SSSE40-60B	1.8	NR	NR	NR	NR	NR	NR	NR

NOTES

1. Allowable EPA, to determine max pole loading weight, multiply allowable EPA by 30 lbs.
2. The tables for allowable pole EPA are based on the ASCE 7-05 Wind Map or the Florida Region Wind Map for the 2010 Florida Building Code. The Wind Maps are intended only as a general guide and cannot be used in conjunction with other maps. Always consult local authorities to determine maximum wind velocities, gusting and unique wind conditions for each specific application
3. Allowable pole EPA for jobsite wind conditions must be equal to or greater than the total EPA for fixtures, arms, and accessories to be assembled to the pole. Responsibility lies with the specifier for correct pole selection. Installation of poles without luminaires or attachment of any unauthorized accessories to poles is discouraged and shall void the manufacturer's warranty
4. Wind speeds and listed EPAs are for ground mounted installations. Poles mounted on structures (such as bridges and buildings) must consider vibration and coefficient of height factors beyond this general guide; Consult local and federal standards
5. Wind Induced Vibration brought on by steady, unidirectional winds and other unpredictable aerodynamic forces are not included in wind velocity ratings. Consult Current's Pole Vibration Application Guide for environmental risk factors and design considerations:
<http://images.salsify.com/image/upload/s--Uk0Lfj10--/bf7prkg0aey64uqoipso>
6. Extreme Wind Events like, Hurricanes, Typhoons, Cyclones, or Tornadoes may expose poles to flying debris, wind shear or other detrimental effects not included in wind velocity ratings

Due to our continued efforts to improve our products, product specifications are subject to change without notice.

Unwrap poles immediately upon receipt to avoid condensation build up and possible corrosion.

Note: There will be a weld witness mark on the side of the pole with the Factory installed VM2.